

Article number: 12348000160110

Description: KLEE-coil 348 000 160.110
M 16 Hardened/zinc-plated Blue

Measures

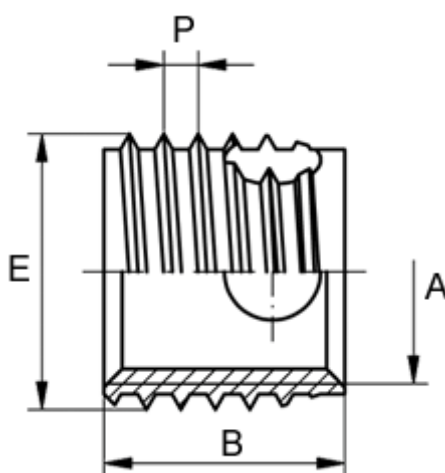

Female thread A	= M16
Length B	= 24
Male thread E	= 18.0
Min hole depth blind hole	= 28
Pre-drilled max	= 17.4
Pre-drilled min	= 17.1
Thread pitch P	= 2.00
Type	= 348 000 160 ...